

HSF

NOTES:

- 1.Electrical Performance:
 - 1-1.Current Rating:0.5 A at AC 100V.
 - 1-2.Withstand Voltage:250V AC.
 - 1-3.Contact Resistance:See Table. $\Delta 3$
 - 1-4.Insulation Resistance:1000M Ω Min.
 - 1-5.Operation Temperature:-55 $^{\circ}$ Cto+85 $^{\circ}$ C
- 2.Material:
 - 2-1.Housing:LCP;Black/Natural;UL94V-0 $\Delta 3$
 - 2-2.Contact:Phosphor Bronze,T=0.20mm.
 - 2-3.Fitting Nail:Brass,T=0.25mm.
 - 2-4.Metal Cap :Stainless Steel,T=0.20mm.
- 3.Finish:
 - 3-1.Contact:Gold Plating On Contact Area;
Matte Tin Plating On Solder Tails,Over Ni.
 - 3-2.Fitting Nail:Sn Plating Over Ni Under Plating

Flatness: <80Pins The "M" Is 0.12mm MAX
 ≥80Pins The "M" Is 0.15mm MAX

Ordering Information

3660-PXXX - XXX XX R 01

No.of Pins Housing High Contact Plating R=Tape&Reel+CAP

G1=3u"Gold
 G2=5u"Gold
 G3=10u"Gold
 S1=3u"Gold/Tin
 S2=5u"Gold/Tin
 S3=10u"Gold/Tin

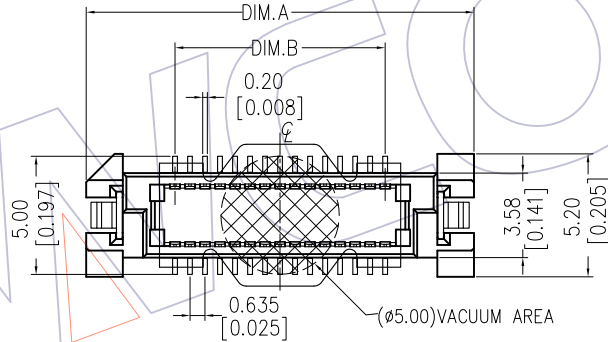
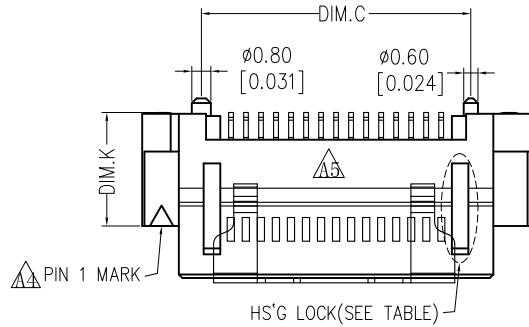

Recommended P.C.B Layout (Top Side)
 (PCB BOARD TOLERANCE ±0.05)

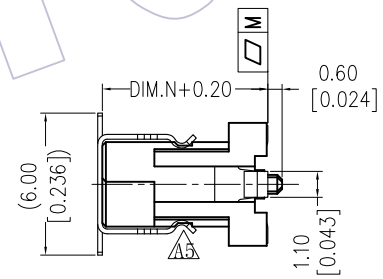
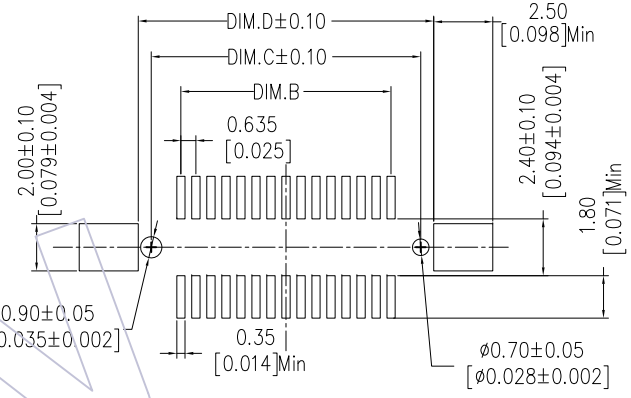

ASS'Y HIGH(H)	$\Delta 3$	
	Before Test	After Test
6.0~7.0	≤40m Ω	≤60m Ω
8.0~10.0	≤50m Ω	≤70m Ω
11.0~13.0	≤60m Ω	≤80m Ω
14.0~16.0	≤70m Ω	≤90m Ω

PART NO.	DIM.N	DIM.K
3660-PXXX-050XXR01	5.00	2.80
3660-PXXX-060XXR01	6.00	3.80
3660-PXXX-070XXR01	7.00	4.80
3660-PXXX-080XXR01	8.00	5.80
3660-PXXX-090XXR01	9.00	6.80

ASS'Y HIGH(H)	PLUG(H1)	SOCKET(H2)
6.00	5.00	4.00
7.00	6.00	
8.00	7.00	
9.00	8.00	
10.00	9.00	10.00
12.00	5.00	
13.00	6.00	
14.00	7.00	
15.00	8.00	
16.00	9.00	

REV	DATE	MODIFICATION DESCRIPTION	CHANGE	OPERATION	DRAW	DATE	SCALE	FIT	PART NO.
A5	2017/07/21	Modify	$\Delta 3$	OPERATION	Ding	2017/07/21	UNIT	mm	3660-PXXX-XXXXXR01
A4	2014/05/07	Modify	$\Delta 4$	±0.40	CHECK	DATE	inch	A4	
A3	2014/03/07	Modify The Contact Resistance	$\Delta 3$	±0.25	APPROVE	DATE	SHEET	1/2	TITLE:
A0	2012/11/20	NEW	—	±0.15	Angle	DATE	PROJ.	◆	0.635mm BTB "M" TYPE MALE 180° SMT $\Delta 3$
				± 3°	DIM	TOL			Customer NO.

WCON
 Http: www.wcon.com

WCON-Dongguan WCON-Kunshan
 Tel: +86 769 85358920 Tel: +86 512 57468408
 Fax: +86 769 85358915 Fax: +86 512 57468468
 E-mail: sales@wcon.com E-mail: salesks@wcon.com

HSF

G3660-PXXX-050DX01

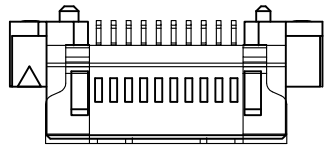

PIN数 < 80P

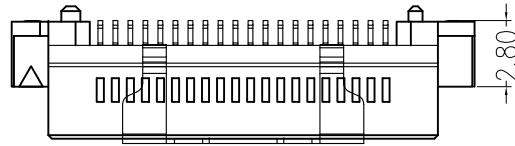

PIN数 ≥ 80P

G3660-PXXX-080DX01

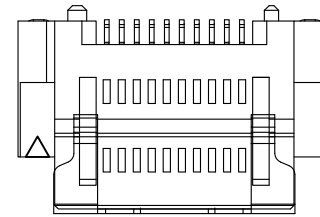

PIN数 < 80P

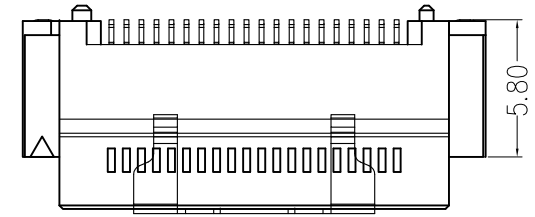

PIN数 ≥ 80P

G3660-PXXX-060DX01

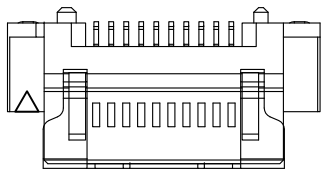

PIN数 < 80P

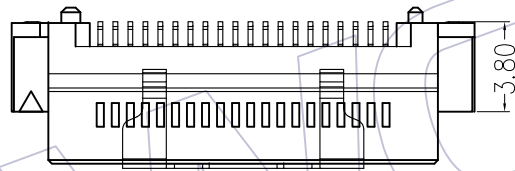

PIN数 ≥ 80P

G3660-PXXX-090DX01

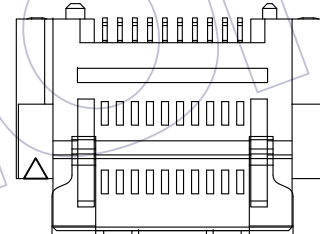

PIN数 < 80P

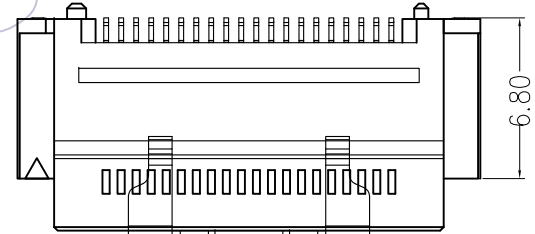

PIN数 ≥ 80P

G3660-PXXX-070DX01

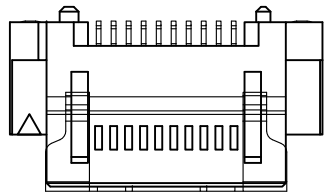

PIN数 < 80P

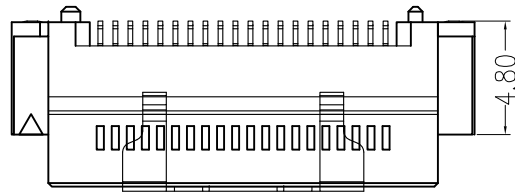

PIN数 ≥ 80P

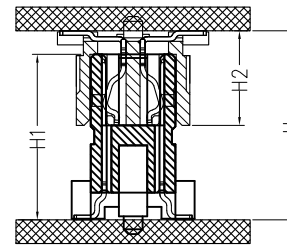

Assembly

NO	53.77	52.67	50.165	57.67	160
	47.42	46.32	43.815	51.32	140
	41.07	39.97	37.465	44.97	120
	34.72	33.62	31.115	38.62	100
	31.55	30.45	27.940	35.45	90
	28.37	27.27	24.765	32.27	80
YES	25.20	24.10	21.590	29.10	70
	22.02	20.92	18.415	25.92	60
	18.85	17.75	15.240	22.75	50
	15.67	14.57	12.065	19.57	40
	12.50	11.40	8.890	16.40	30
	9.32	8.22	5.715	13.22	20
HS'G LOCK	DIM.D	DIM.C	DIM.B	DIM.A	PIN NO.

A5	2017/07/21	Modify	△	OPERATION		DRAW	DATE	SCALE	FIT	PART NO.	<p>WCON Http: www.wcon.com WCON-Dongguan Tel: +86 769 85358920 WCON-Kunshan Tel: +86 512 57468408 Fax: +86 769 85358915 Fax: +86 512 57468468 E-mail: sales@wcon.com E-mail: salesks@wcon.com</p>
A4	2014/05/07	Modify		X.X	±0.40						
A3	2014/03/07	Modify The Contact Resistance	△	X.XX	±0.25	CHECK	DATE	inch	TITLE:		
A0	2012/11/20	NEW	—	X.XXX	±0.15	APPROVE	DATE	SIZE	A4	0.635mm BTB "M" TYPE MALE 180° SMT △	
REV	DATE	MODIFICATION DESCRIPTION	CHANGE	Angle	± 3'			DIM	TOL	SHEET	